

EXAMPLE CONNECTIONS

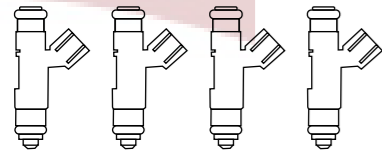

INJECTORS

INJECTORS
 4 X INJECTOR DRIVERS
 CURRENT CONTROLLED
 • 0A - 8A PEAK CURRENT
 • 0A - 2A HOLD CURRENT
 INJECTOR OUTPUTS CAN BE USED AS GENERIC DPO'S WITH 1A MAX OUTPUT
 WIRE INJECTOR OUTPUT TO CYLINDER NUMBER
 OUTPUT: GROUND

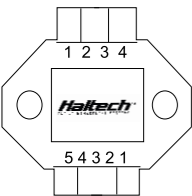
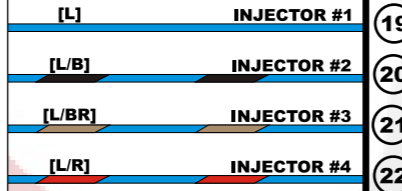

IGNITION MODULE

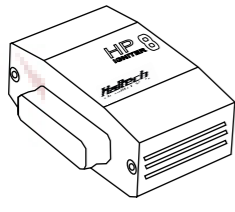

HALTECH HPI

IGNITION
 4 X IGNITION DRIVERS
 • 1A MAX CURRENT
 • OVERCURRENT PROTECTED
 IGNITION OUTPUTS CAN BE USED AS GENERIC DPO'S WITH 1A MAX OUTPUT
 WIRE IGNITION OUTPUT TO CYLINDER NUMBER FOR DIRECT FIRE
 OUTPUT: GROUND

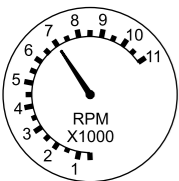
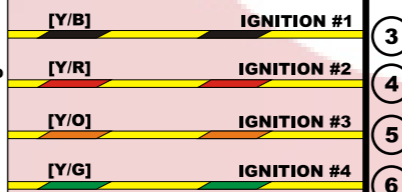

TACHOMETER

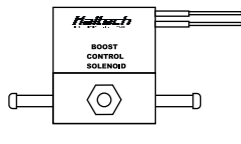

BOOST CONTROL SOLENOID

DPO
 6 X DIGITAL PULSED OUTPUTS
 • LOW SIDE DRIVE
 • 1A MAX CURRENT
 • OVERCURRENT PROTECTED
 OUTPUT: GROUND

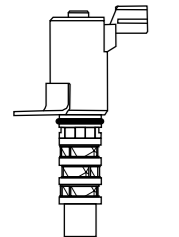
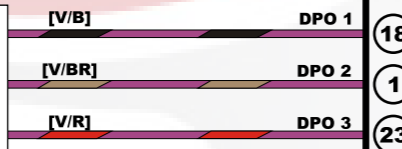

VTEC SOLENOIDS

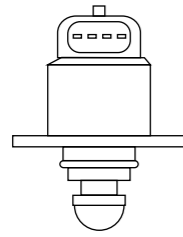

IDLE MOTOR

STEPPER 1 / DPO
 CAN BE CONFIGURED AS
 • 1 X STEPPER MOTOR DRIVER PAIRED P1 & P2 / P3 & P4
 • 4 X HI/LOW SIDE DRIVERS
 SPECIFICATIONS
 • 1A MAX CURRENT DRIVE
 • 1A MAX CURRENT SINK
 • OVERCURRENT PROTECTED
 OUTPUT: BATT V OR GROUND

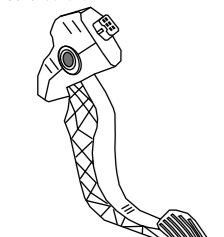
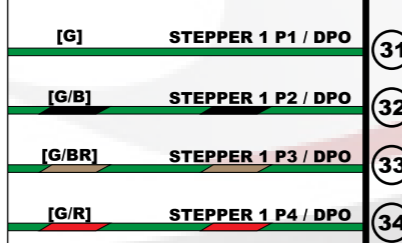

ACCELERATOR PEDAL POSITION SENSOR

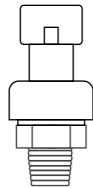

PRESSURE SENSORS

AVI
 10 X ANALOGUE VOLTAGE INPUTS
 • SWITCHABLE 1K PULL-UP
 • 20V MAX INPUT VOLTAGE
 • 1.5KHz MAX INPUT FREQUENCY
 INPUT: 0V - 5V (20V MAXIMUM)
 +5V SENSOR SUPPLY
 • 100mA MAX OUTPUT CURRENT
 +8V SENSOR SUPPLY
 • 1A MAX OUTPUT CURRENT

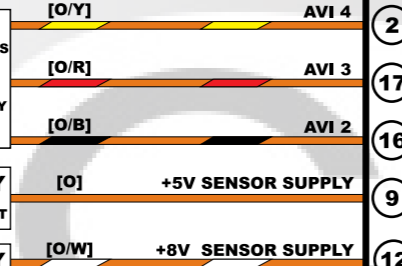

LOOKING INTO CONNECTOR ON ECU

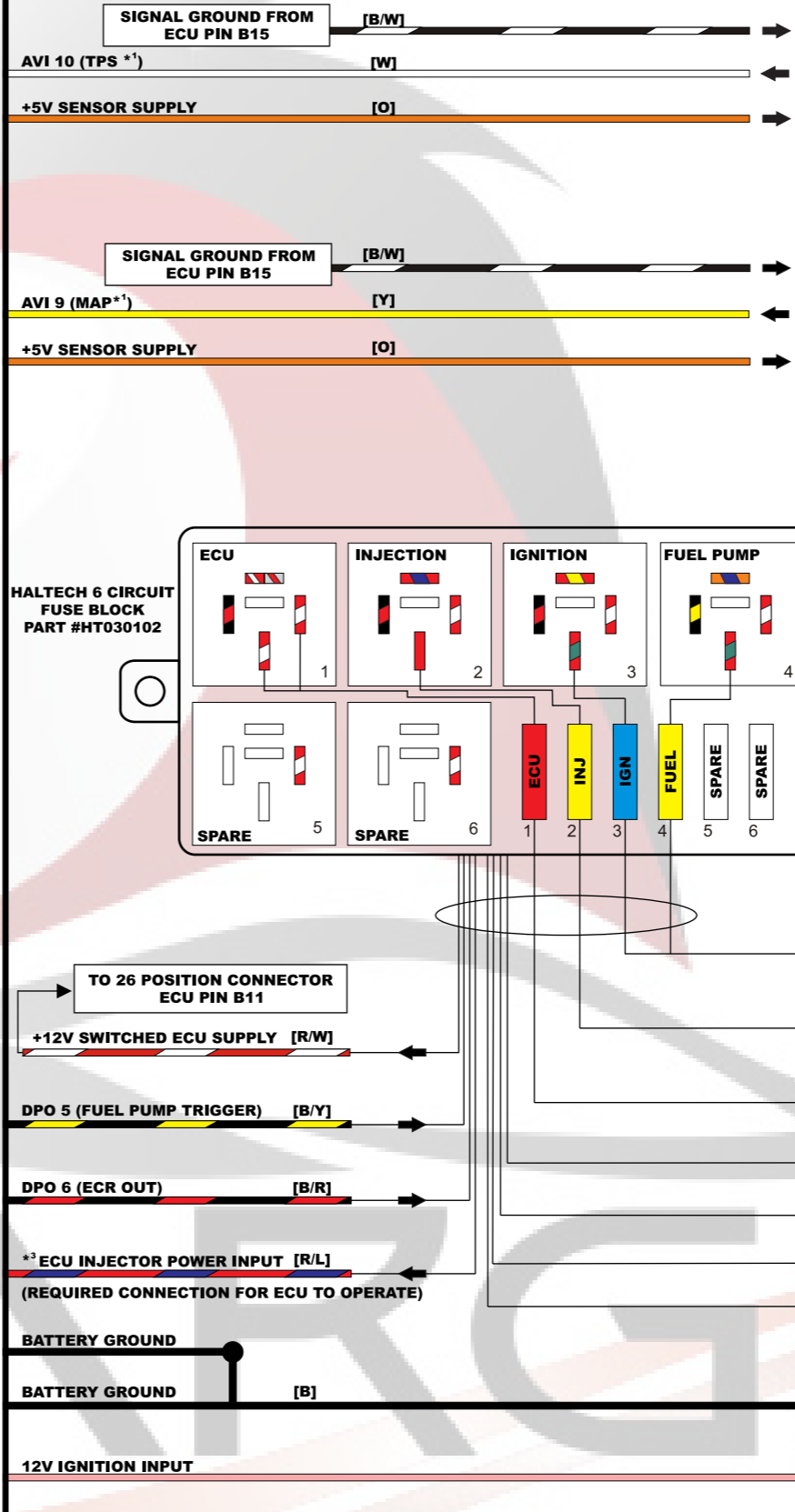
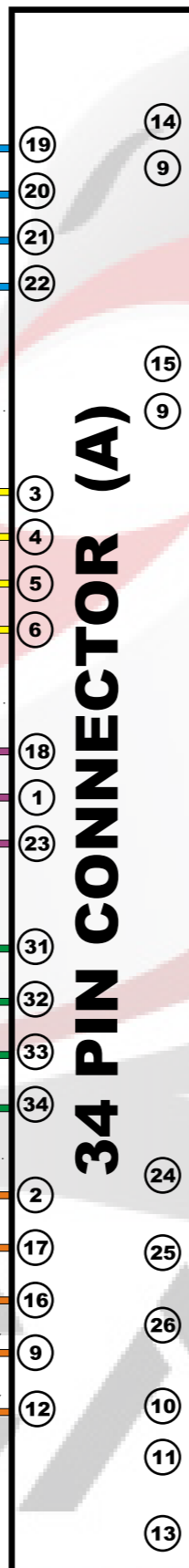
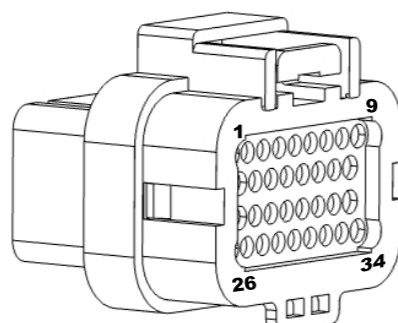
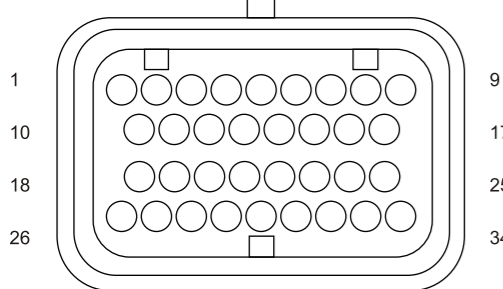

EXAMPLE CONNECTIONS

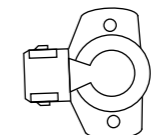

THROTTLE POSITION SENSORS

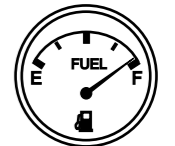

FUEL LEVEL SENSOR

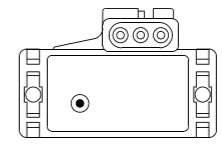

MANIFOLD ABSOLUTE PRESSURE SENSOR

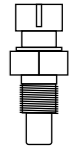

TEMPERATURE SENSORS

FUSE BLOCK NOTES:
 15A CONTINUOUS, 20A PEAK
 MAX CURRENT RATING PER CIRCUIT

FUSE ALLOCATIONS
 FUSE 1: 10A - ECU
 FUSE 2: 20A - INJECTION
 FUSE 3: 15A - IGNITION
 FUSE 4: 20A - FUEL PUMP
 FUSE 5: SPARE
 FUSE 6: SPARE

RELAY PIN LAYOUT & SCHEMATIC

SUITS 4 OR 5 PIN STANDARD BOSCH RELAY

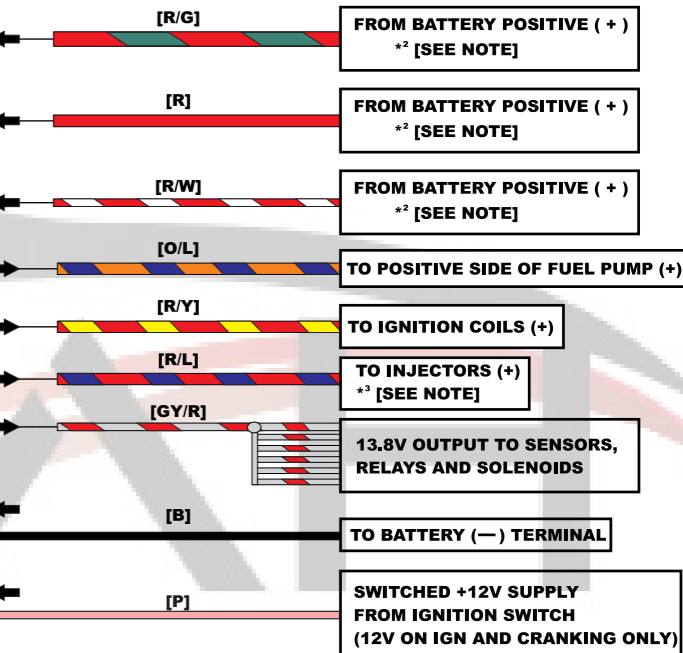

LEGEND - WIRE COLOUR
 B = BLACK BR = BROWN G = GREEN GY = GREY L = BLUE
 O = ORANGE P = PINK R = RED V = VIOLET Y = YELLOW W = WHITE
 WHEN TWO COLOURS ARE USED IN A WIRE BY THE ALPHABETICAL CODE, THE FIRST LETTER INDICATES THE BASIC WIRE COLOUR, THE SECOND COLOUR INDICATES THE COLOUR OF THE STRIPE.

NOTES:
 *1 RECOMMENDED FUNCTION ALLOCATION, BUT NOT LIMITED TO
 *2 CAN USE 75A CIRCUIT BREAKER
 *3 DBW AND STEPPER SUPPLY, CURRENT RETURN PATH

EXAMPLE CONNECTIONS

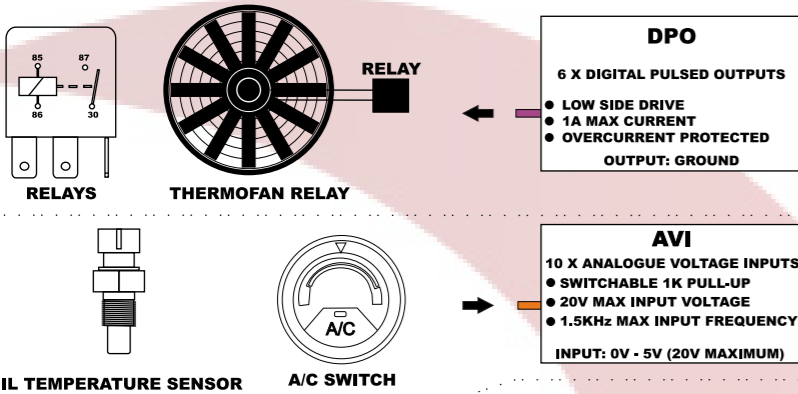

EXAMPLE CONNECTIONS

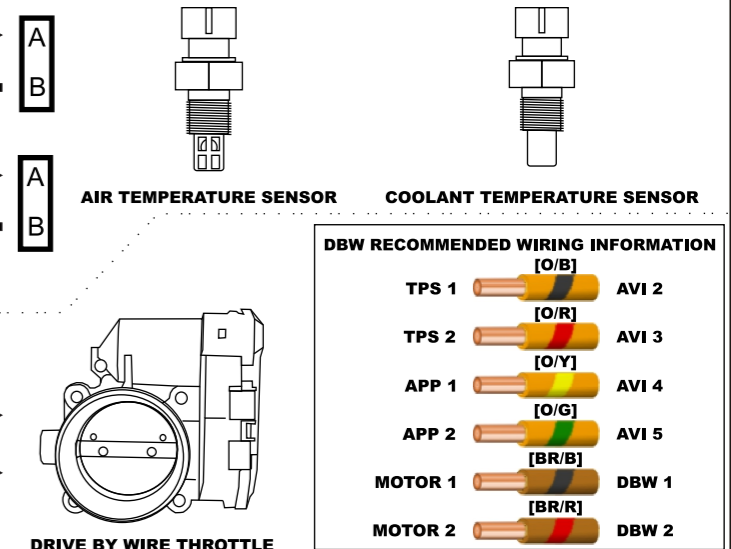

DBW RECOMMENDED WIRING INFORMATION [O/B]		
TPS 1	[O/B]	AVI 2
TPS 2	[O/R]	AVI 3
APP 1	[O/Y]	AVI 4
APP 2	[O/G]	AVI 5
MOTOR 1	[BR/B]	DBW 1
MOTOR 2	[BR/R]	DBW 2

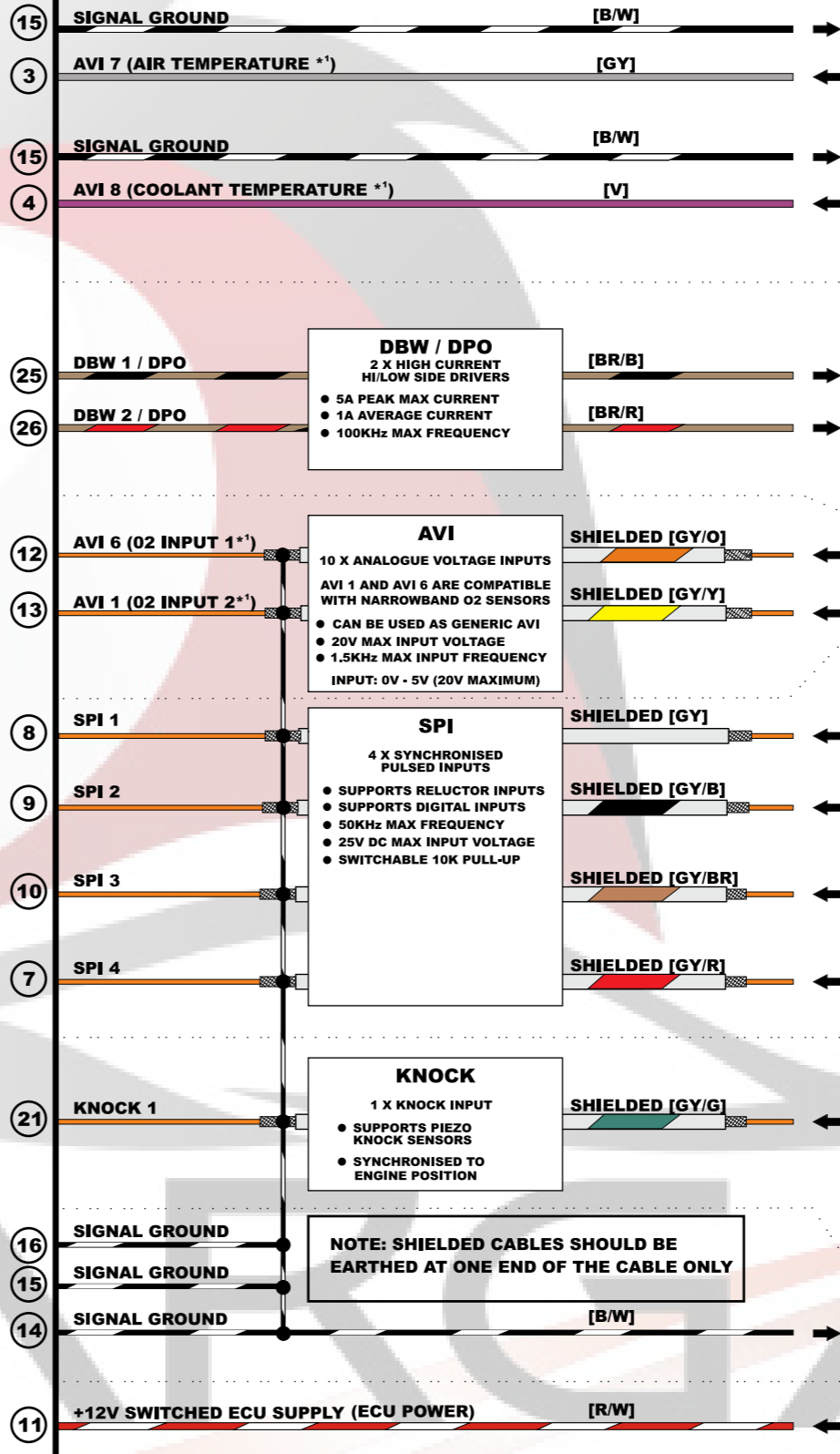
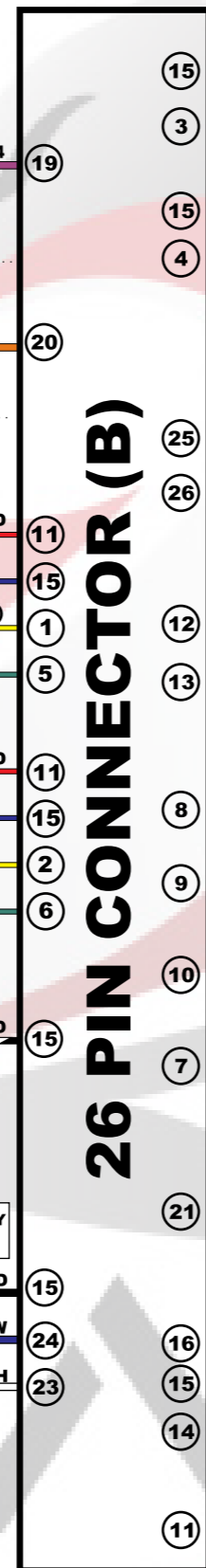

CRANK (TRIGGER) INPUT

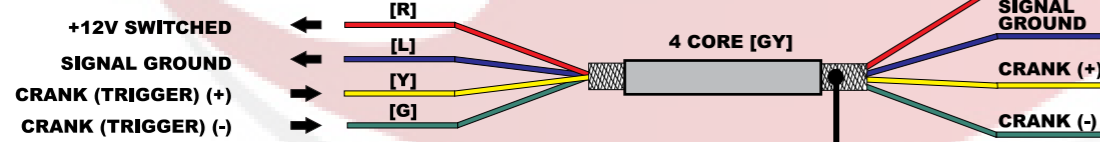

CAM (HOME) INPUT

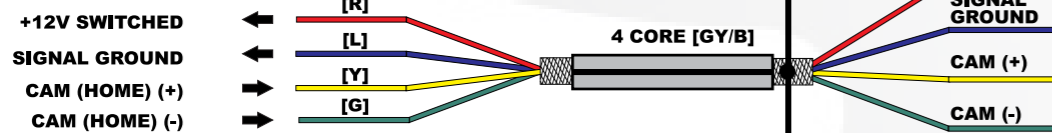

CRANK AND CAM SENSOR WIRING INFORMATION

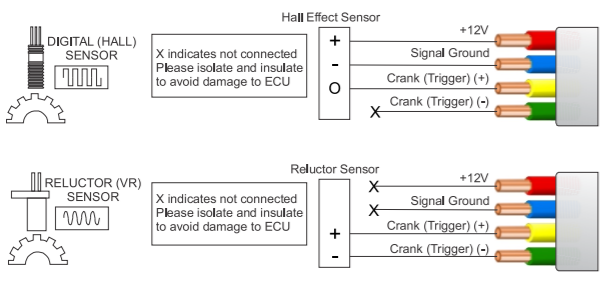

MAIN HARNESS CAN CONNECTOR (DTM04-4P)

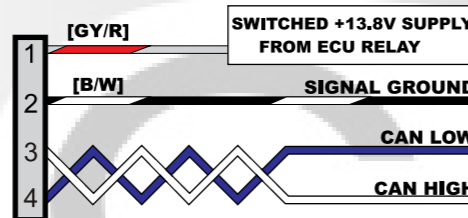

CAN (ISO 11898)

- SUPPORTS SPEEDS UP TO 1Mbits/s
- HALTECH BUS**
 - SUPPORTS ALL HALTECH EXPANSION PRODUCTS
- VEHICLE BUS**
 - SELECTABLE PRECONFIGURED VEHICLE CAN INTERFACE
 - OBDSII COMPLIANT

LOOKING INTO CONNECTOR ON ECU

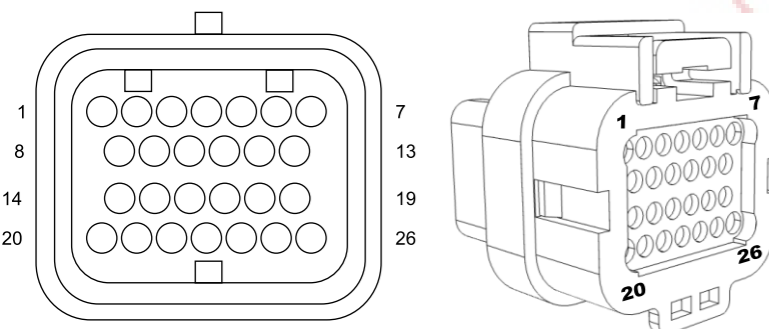

LEGEND - WIRE COLOUR

B = BLACK BR = BROWN G = GREEN GY = GREY L = BLUE
O = ORANGE P = PINK R = RED V = VIOLET Y = YELLOW W = WHITE
WHEN TWO COLOURS ARE USED IN A WIRE BY THE ALPHABETICAL CODE, THE FIRST LETTER INDICATES THE BASIC WIRE COLOUR, THE SECOND COLOUR INDICATES THE COLOUR OF THE STRIPE.

NOTES:

- *1 RECOMMENDED FUNCTION ALLOCATION, BUT NOT LIMITED TO
- *2 CAN USE 75A CIRCUIT BREAKER
- *3 DBW AND STEPPER SUPPLY, CURRENT RETURN PATH